

## ■ Stex 45 Threaded bolt GB M10 x 90 mm

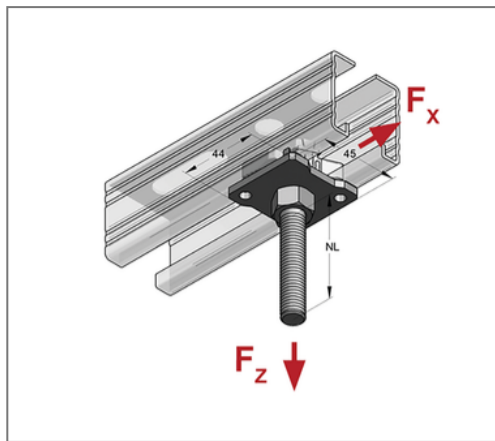
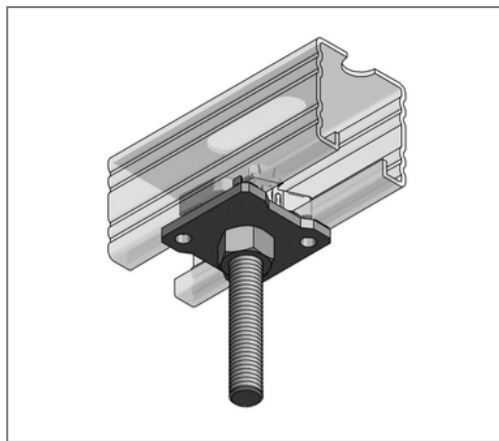

### Commercial details

Part no.	1282090
EAN/GTIN	4250928424808
Packing unit	20 pcs
Quantity unit	pcs
Weight	0,166 kg/pc
Product group	02-128
Price unit	1

### QR code



### Specification

Application quick-fixing system for direct pipe clamp  
area attachment to Stex profile rails with permanently  
integrated threaded bolt and nut.

### Technical data

Material	Steel
Material type	S235
Surface	galvanized
Strength class	4.6

### Product details

Thread	M10
Length thread	90 mm
Usable length	50 mm