

## ■ Stex 45 Threaded bolt GB M8 x 50 mm

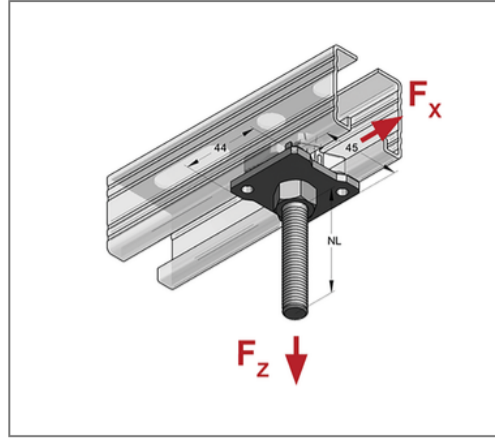
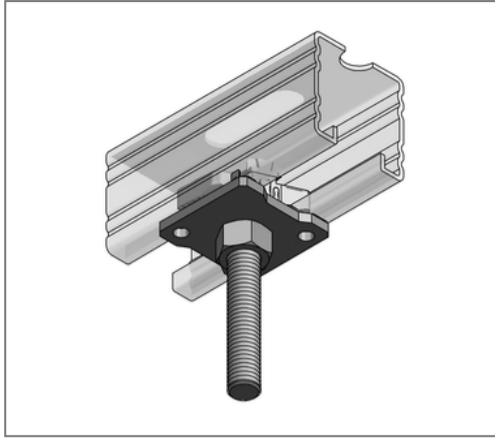

### Commercial details

Part no.	1281050
EAN/GTIN	4250928424730
Packing unit	40 pcs
Quantity unit	pcs
Weight	0,134 kg/pc
Product group	02-128
Price unit	1

### QR code



### Specification

Application area	quick-fixing system for direct pipe clamp attachment to Stex profile rails with permanently integrated threaded bolt and nut.
------------------	---

### Technical data

Material	Steel
Material type	S235
Surface	galvanized
Strength class	4.6

### Product details

Thread	M8
Length thread	50 mm
Usable length	11 mm