

## ■ Console Stex 35/35 L= 525 mm Plate vertical galv.

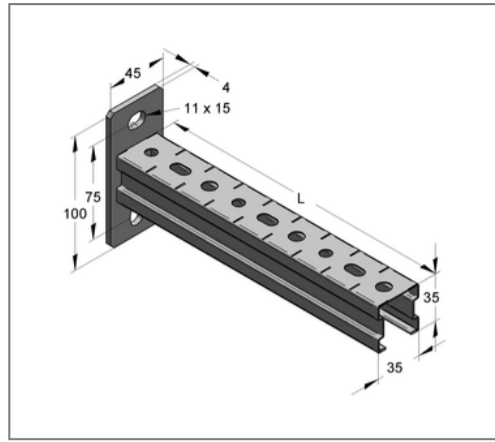
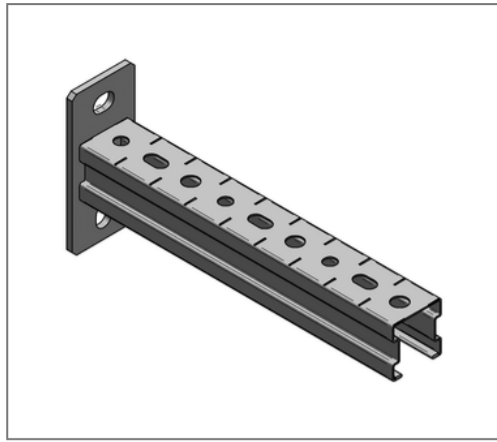

### Commercial details

Part no.	1274525
EAN/GTIN	4250928424525
Packing unit	20 pcs
Quantity unit	pcs
Weight	0,671 kg/pc
Product group	02-127
Price unit	1

### QR code



### Specification

Application area	Console for the production of cantilever structures for the support of suspended and standing pipe loads.
------------------	---

### Technical data

Material	Steel
Surface	galvanized

### Product details

Width plate	45 mm
Length plate	100 mm
Hole distance	75 mm
Plate thickness	4 mm
Width profile	35 mm
Profile height	35 mm
Length console L	525 mm
Elongated hole plate	11x15 mm
load F1	0,59 kN
load F2	0,28 kN
load q0	1,11 kN/m
Profile thickness	1 mm