

■ U-bolt 26,9 mm M8 total height 85 mm

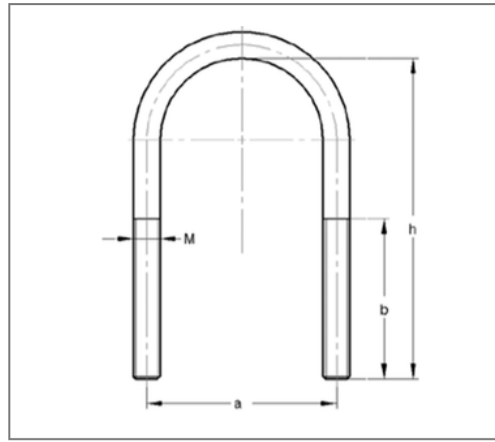

Commercial details

Part no.	050702801
EAN/GTIN	4250928463760
Packing unit	100 pcs
Quantity unit	pcs
Weight	0,0623 kg/pc
Product group	01-050
Price unit	1

QR code



Specification

Application area	for direct installation of piping onto steel structures and suitable for push-through-assembling into profile rails. Suitable for sprinkler
------------------	---

Specification	similar to DIN 3570
---------------	---------------------

Technical data

Material	Steel
Material type	S235
Surface	galvanized

Product details

Center distance a	35 mm
Height h	85 mm
Outside pipe diameter inch	3/4 inch
Thread M	M8
Length thread b	65 mm
Outer pipe diameter	26,9 mm

Remark

Notice	without nut
--------	-------------