

■ Console C-profile 45/26 S L= 210 mm Plate vertical galv.

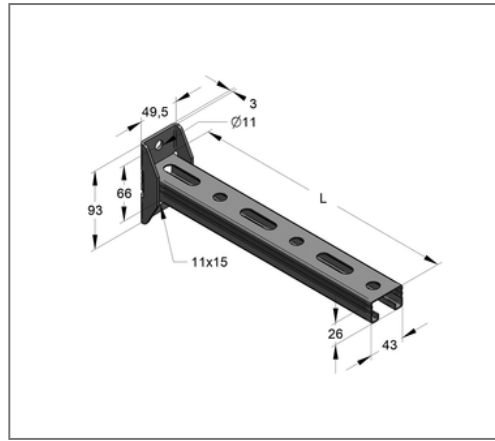
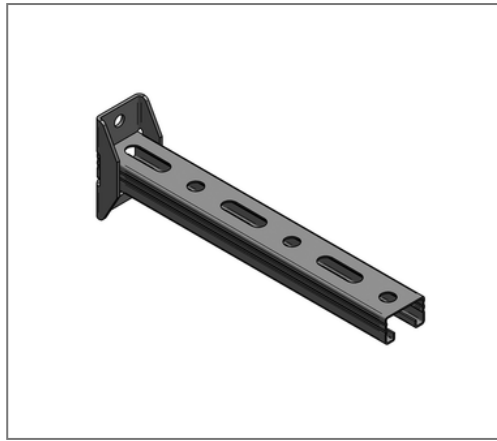

Commercial details

Part no.	18035021001
EAN/GTIN	4250928456731
Packing unit	25 pcs
Quantity unit	pcs
Weight	0,419 kg/pc
Product group	02-083
Price unit	1

QR code



Specification

Application area	Console for the production of cantilever structures for the support of suspended and standing pipe loads.
------------------	---

Technical data

Material	Steel
Surface	galvanized

Product details

Width plate	49,5 mm
Length plate	93 mm
Hole distance	66 mm
Plate thickness	3 mm
Width profile	45 mm
Profile height	26 mm
Length console L	210 mm
Elongated hole plate	11x15 mm
load F1	1,18 kN
load F2	0,59 kN
load q0	5,6 kN/m
Profile thickness	1,5 mm