

■ Hammer head C-profile 35 M12 x 70 mm

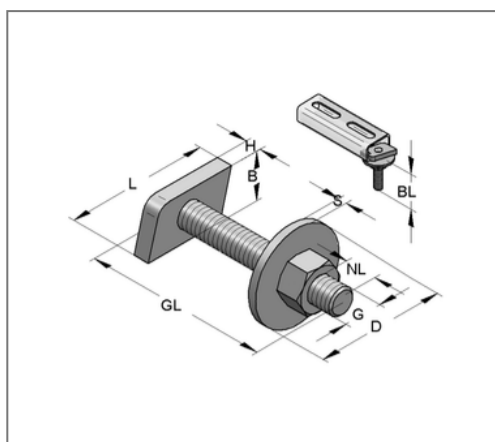
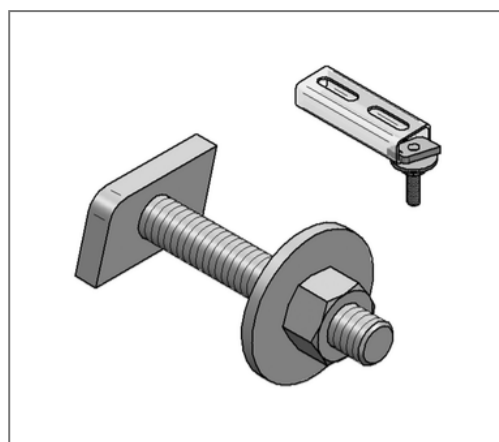

Commercial details

Part no.	0698070
EAN/GTIN	4250928415868
Packing unit	50 pcs
Quantity unit	pcs
Weight	0,111 kg/pc
Product group	02-069
Price unit	100

QR code



Specification

Application area	Should preferably be used for pipe clamp mounting
Profile type	35, Stex 35
Type of attachment	For glide fast connections and shear hole haunch connections with MEFA profile rails

Technical data

Material	Steel
Material type	S235
Surface	galvanized

Product details

Thread G	M12
Length thread GL	70 mm
Usable length NL	49 mm
Overall length BL	62 mm
Length hammer head L	35 mm
Width hammer head H	18 mm
Thickness hammer head H	6 mm
Diameter washer D	37 mm
Thickness washer S	3 mm