

■ Console C-profile 45/26 S L= 315 mm Plate vertical galv.

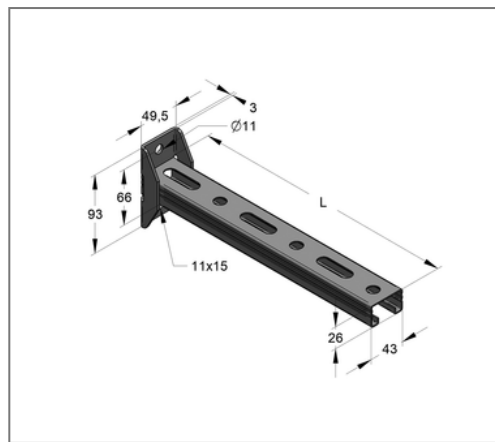

Commercial details

Part no.	18035031501
EAN/GTIN	4250928456489
Packing unit	25 pcs
Quantity unit	pcs
Weight	0,560 kg/pc
Product group	02-083
Price unit	1

QR code



Specification

Application area	Console for the production of cantilever structures for the support of suspended and standing pipe loads.
------------------	---

Technical data

Material	Steel
Surface	galvanized

Product details

Width plate	49,5 mm
Length plate	93 mm
Hole distance	66 mm
Plate thickness	3 mm
Width profile	45 mm
Profile height	26 mm
Length console L	315 mm
Elongated hole plate	11x15 mm
load F1	0,78 kN
load F2	0,39 kN
load q0	2,49 kN/m
Profile thickness	1,5 mm