

■ Console C-profile 45/60 L= 525 mm Plate vertical galv.

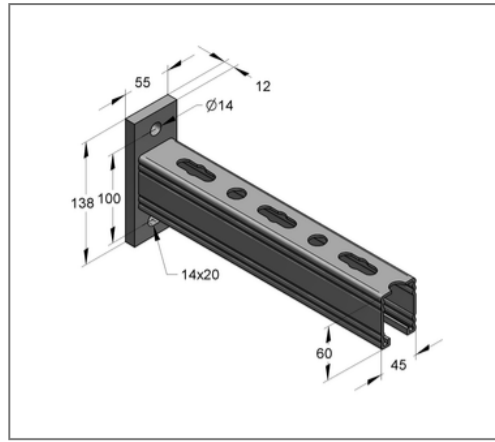
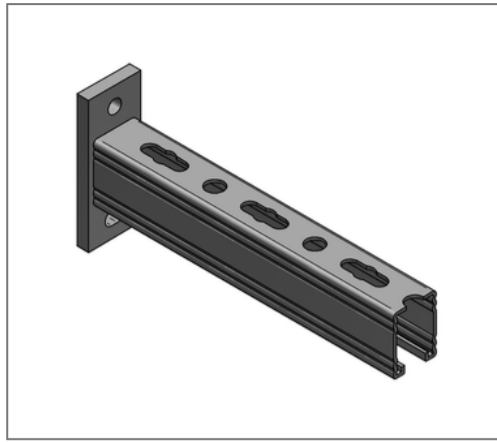

Commercial details

Part no.	18050525
EAN/GTIN	4250928437648
Packing unit	5 pcs
Quantity unit	pcs
Weight	2,80 kg/pc
Product group	02-083
Price unit	1

QR code



Specification

Application area	Console for the production of cantilever structures for the support of suspended and standing pipe loads.
------------------	---

Technical data

Material	Steel
Surface	galvanized

Product details

Width plate	55 mm
Length plate	138 mm
Hole distance	100 mm
Plate thickness	12 mm
Width profile	45 mm
Profile height	60 mm
Length console L	525 mm
Elongated hole plate	14x20 mm
load F1	4,36 kN
load F2	2,18 kN
load q0	8,3 kN/m
Profile thickness	3 mm