

■ Console C-profile 45/90 L= 840 mm Plate vertical hot-dip galv.

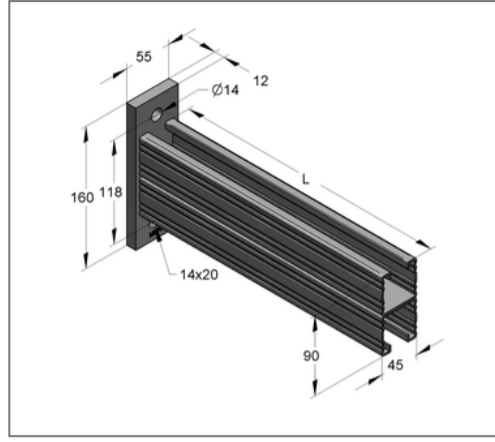
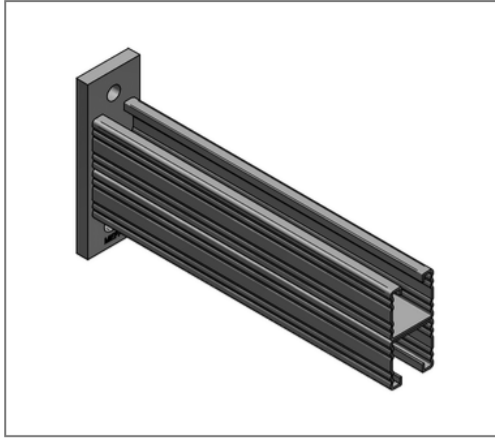

Commercial details

Part no.	180900840/fvz
EAN/GTIN	4250928448385
Packing unit	5 pcs
Quantity unit	pcs
Weight	5,31 kg/pc
Product group	02-083
Price unit	1

QR code



Certification



Specification

Application area	Console for the production of cantilever structures for the support of suspended and standing pipe loads.
------------------	---

Technical data

Material	Steel
Surface	hot-dip galvanized

Product details

Width plate	55 mm
Length plate	160 mm
Hole distance	118 mm
Plate thickness	12 mm
Width profile	45 mm
Profile height	90 mm
Length console L	840 mm
Elongated hole plate	14x20 mm
load F1	3,72 kN
load F2	1,86 kN
load q0	4,43 kN/m
Profile thickness	2 mm