

■ Console C-profile 35/21 L= 525 mm Plate vertical galv.

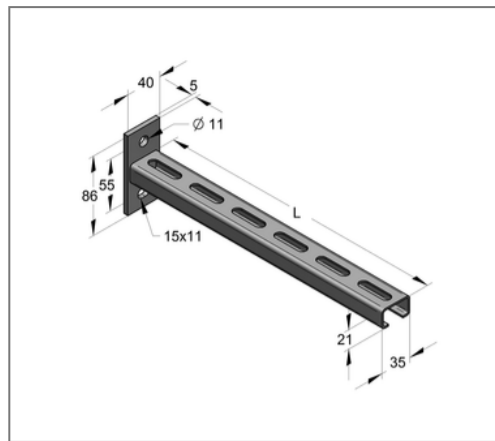

Commercial details

Part no.	18020525
EAN/GTIN	4250928437501
Packing unit	25 pcs
Quantity unit	pcs
Weight	0,734 kg/pc
Product group	02-083
Price unit	1

QR code



Specification

Application area	Console for the production of cantilever structures for the support of suspended and standing pipe loads.
------------------	---

Technical data

Material	Steel
Surface	galvanized

Product details

Width plate	40 mm
Length plate	86 mm
Hole distance	55 mm
Plate thickness	5 mm
Width profile	35 mm
Profile height	21 mm
Length console L	525 mm
Elongated hole plate	11x15 mm
load F1	0,36 kN
load F2	0,12 kN
load q0	0,62 kN/m
Profile thickness	2 mm