

## ■ U-bolt 159 mm M12 total height 240 mm

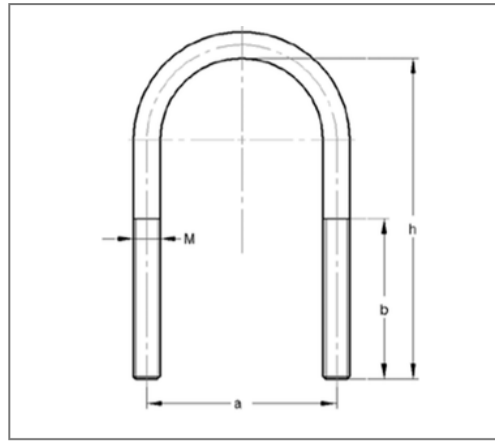

### Commercial details

Part no.	0507159
EAN/GTIN	4250928414342
Packing unit	25 pcs
Quantity unit	pcs
Weight	0,416 kg/pc
Product group	01-050
Price unit	1

### QR code



### Specification

Application area	for direct installation of piping onto steel structures and suitable for push-through-assembling into profile rails. Suitable for sprinkler
------------------	---

Specification	similar to DIN 3570
---------------	---------------------

### Technical data

Material	Steel
Material type	S235
Surface	galvanized

### Product details

Center distance a	172 mm
Height h	240 mm
Thread M	M12
Length thread b	90 mm
Outer pipe diameter	159 mm

### Remark

Notice	without nut
--------	-------------