

■ Hammer head C-profile 35 M12 x 35 mm

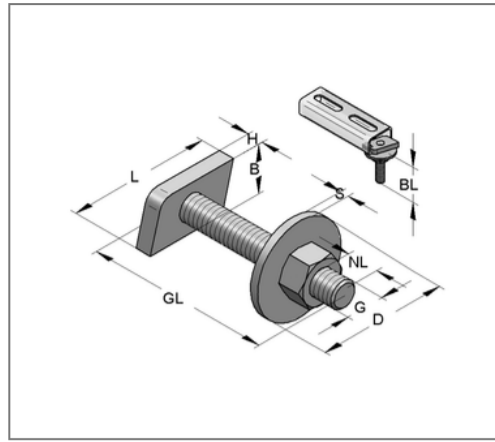
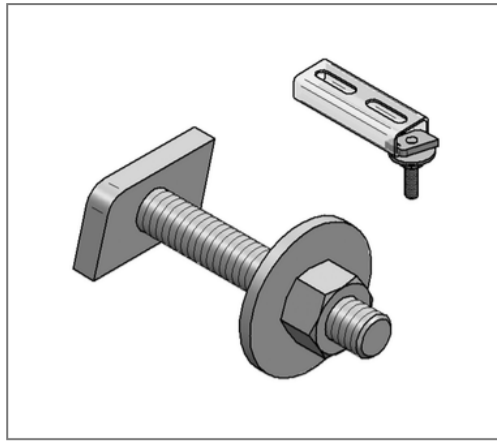

Commercial details

Part no.	0698040
EAN/GTIN	4250928415844
Packing unit	50 pcs
Quantity unit	pcs
Weight	0,0853 kg/pc
Product group	02-069
Price unit	100

QR code



Specification

Application area	Should preferably be used for pipe clamp mounting
Profile type	35, Stex 35
Type of attachment	For glide fast connections and shear hole haunch connections with MEFA profile rails

Technical data

Material	Steel
Material type	S235
Surface	galvanized

Product details

Thread G	M12
Length thread GL	35 mm
Usable length NL	14 mm
Overall length BL	27 mm
Length hammer head L	35 mm
Width hammer head H	18 mm
Thickness hammer head H	6 mm
Diameter washer D	37 mm
Thickness washer S	3 mm