

■ Console Stex 35/35 L= 450 mm Plate vertical galv.

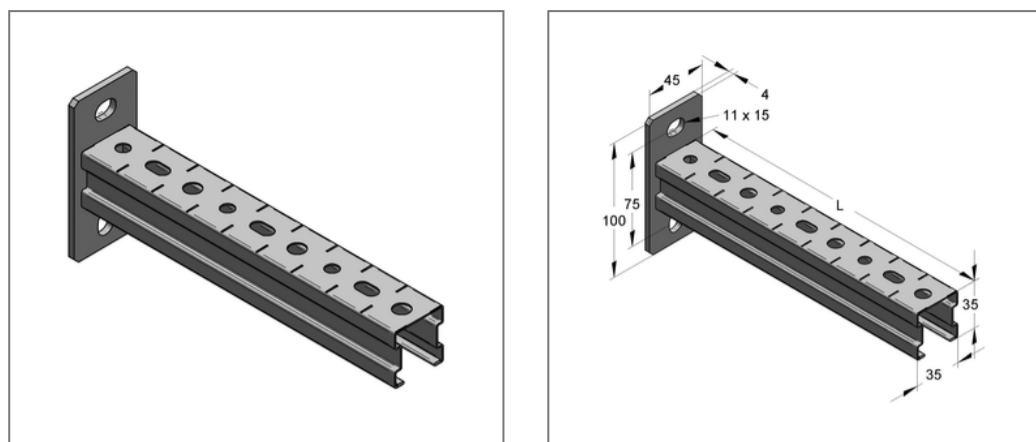

Commercial details

Part no.	1274450
EAN/GTIN	4250928424518
Packing unit	20 pcs
Quantity unit	pcs
Weight	0,594 kg/pc
Product group	02-127
Price unit	1

QR code



Specification

Application area	Console for the production of cantilever structures for the support of suspended and standing pipe loads.
------------------	---

Technical data

Material	Steel
Surface	galvanized

Product details

Width plate	45 mm
Length plate	100 mm
Hole distance	75 mm
Plate thickness	4 mm
Width profile	35 mm
Profile height	35 mm
Length console L	450 mm
Elongated hole plate	11x15 mm
load F1	0,68 kN
load F2	0,34 kN
load q0	1,52 kN/m
Profile thickness	1 mm