

■ Protecting cap C-profile Stex 35 for profile 35/35 PE black

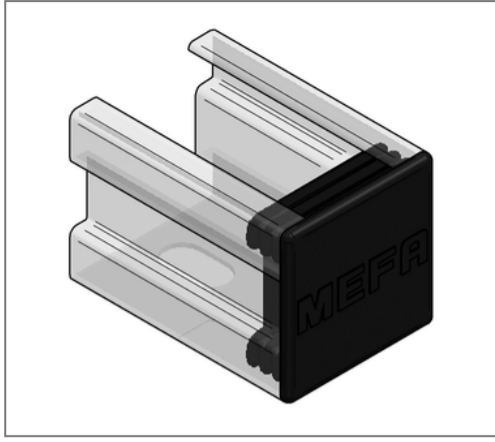

Commercial details

Part no.	1272016
EAN/GTIN	4250928424341
Packing unit	50 pcs
Quantity unit	pcs
Weight	0,0045 kg/pc
Product group	02-127
Price unit	1

QR code



Technical data

Material	Plastic
Material type	PE
Colour	black

Specification

Application area	Plastic end caps for mounting rails. To protect the edges and as an optical cover.
Profile type	35/35