

■ Pipe clamp Trabant 20x1 21 - 25 mm M8/M10 EPDM

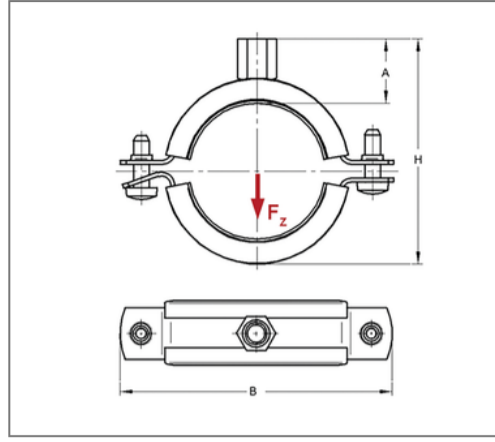

Commercial details

Part no.	042625101
EAN/GTIN	4250928409195
Packing unit	100 pcs
Quantity unit	pcs
Weight	0,0580 kg/pc
Product group	01-042
Price unit	100

QR code



Certification



Specification

Application area	Pipe clamp for fixing pipes.
Specification	two-part
Connection	M8/M10
Closure	Snap-in closure

Technical data

Material	Steel
Material type	DD11
Surface	galvanized
Insulation thickness	4,5 mm
Temperature resistance	-35 °C - 100 °C
Sound insulation lining	Rubber EPDM

Product details

Connection height A	22 mm
Width B	69 mm
Colour sound insulation lining	black
Höhe H	48 - 53 mm
Material dimension	20x1 mm
load F_z	0,29 kN
Clamping range	21 - 25 mm
Outside pipe diameter inch	1/2 inch
Closure screw	M6

Remark

Notice	suitable connection adapter see chapter 1
--------	---