

■ Head profile Double C-profile 45/52 Height 52 mm Elongated hole 17,5x13 mm

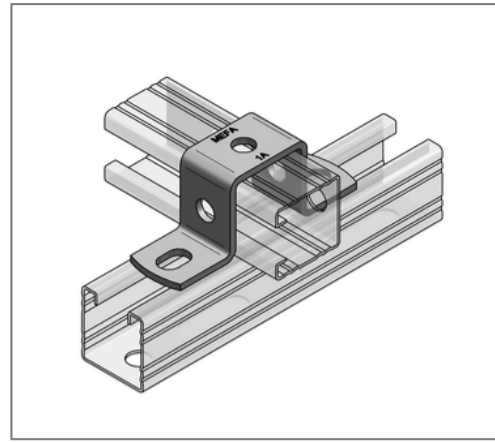
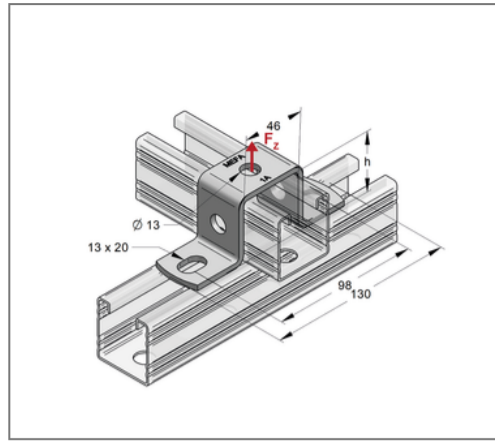
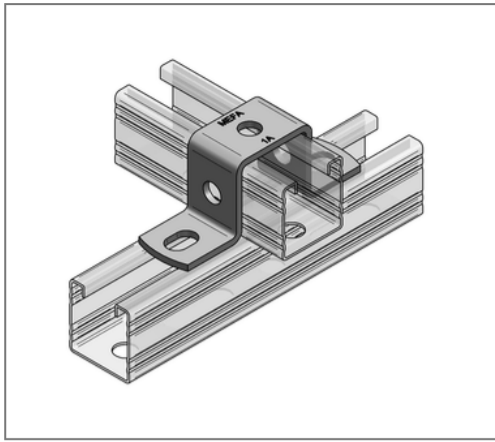

Commercial details

Part no.	08162452
EAN/GTIN	4250928420237
Packing unit	25 pcs
Quantity unit	pcs
Weight	0,235 kg/pc
Product group	02-081
Price unit	1

QR code



Specification

Application	Connecting component for fixing two crossing area
	profile rails.

Technical data

Material	Steel
Material type	S235
Surface	galvanized

Product details

load F_z	3,5 kN
Height h	52 mm
Length	130 mm
Length inside	45 mm
Width material	35 mm
Material thickness	4 mm
Elongated hole	13x17,5 mm
Profile type	45/52
Hole distance	98 mm
Terminal hole	13 mm