

## ■ Hammer head C-profile 45 M8 x 35 mm

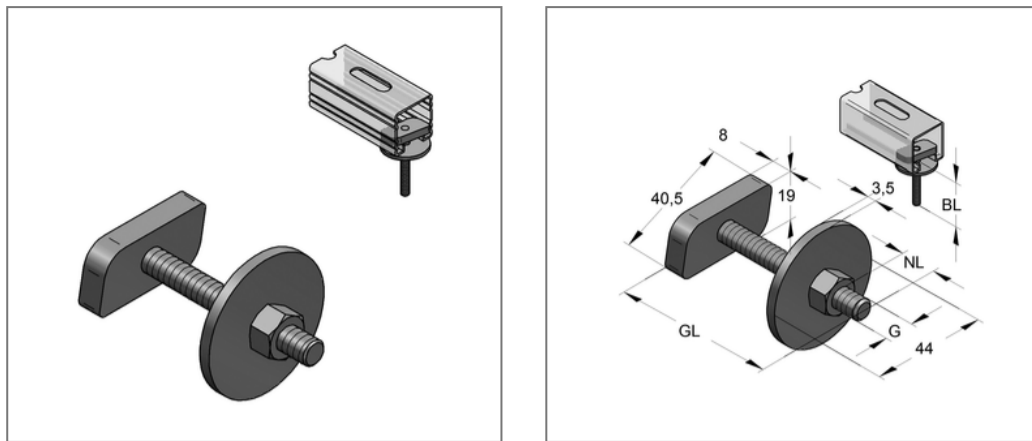

### Commercial details

Part no.	0698735
EAN/GTIN	4250928415875
Packing unit	50 pcs
Quantity unit	pcs
Weight	0,0987 kg/pc
Product group	02-069
Price unit	100

### QR code



### Specification

Application area	Direct attachment of pipe clamps to profile rails.
Profile type	45
Type of attachment	glide fast connection

### Technical data

Material	Steel
Material type	S235
Surface	galvanized

### Product details

Thread G	M8
Length thread GL	35 mm
Usable length NL	9,5 mm
Overall length BL	19,5 mm
Length hammer head	40,5 mm
Width hammer head	19 mm
Thickness hammer head	8 mm
Diameter washer	44 mm
Thickness washer	3,5 mm