

■ Console C-profile 45/52 L= 525 mm Plate vertical galv.

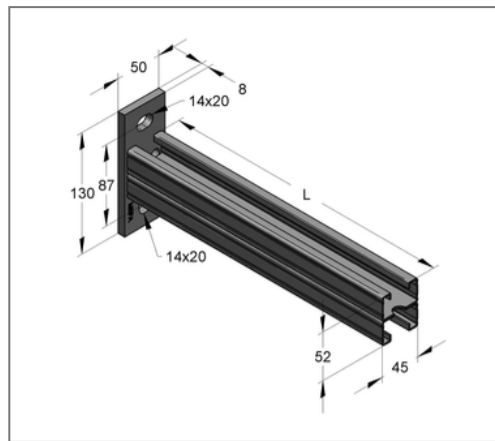

Commercial details

Part no.	18070525
EAN/GTIN	4250928437778
Packing unit	10 pcs
Quantity unit	pcs
Weight	1,78 kg/pc
Product group	02-083
Price unit	1

QR code



Specification

Application area	Console for the production of cantilever structures for the support of suspended and standing pipe loads.
------------------	---

Technical data

Material	Steel
Surface	galvanized

Product details

Width plate	50 mm
Length plate	130 mm
Hole distance	87 mm
Plate thickness	8 mm
Width profile	45 mm
Profile height	52 mm
Length console L	525 mm
Elongated hole plate	14x20 mm
load F1	1,76 kN
load F2	0,88 kN
load q0	3,35 kN/m
Profile thickness	1,5 mm