

■ C-profile lining C-profile 45 10 m Plastic

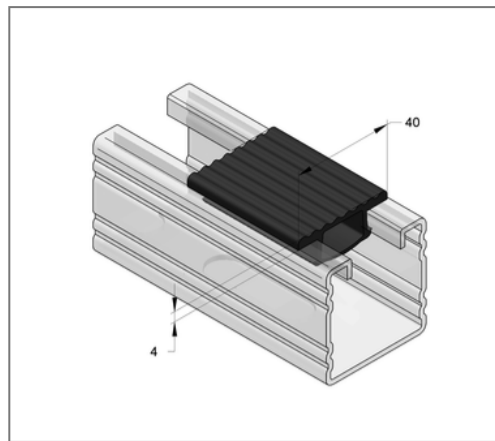
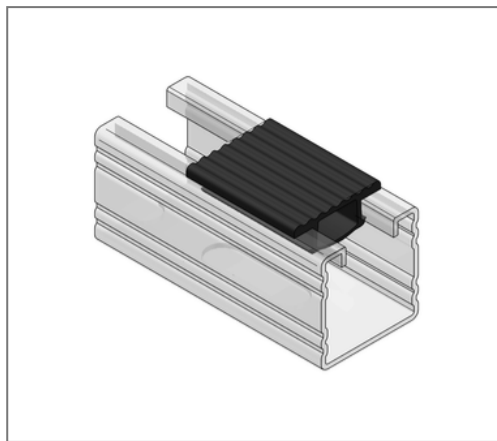

Commercial details

Part no.	710004502
EAN/GTIN	4250928455727
Packing unit	10 m
Quantity unit	m
Weight	0,224 kg/m
Product group	08-710
Price unit	1

QR code



Certification



Specification

Application	c-profile lining between profile rail and part to be supported (e.g. ventilation ducts).
Type of attachment	clamping

Technical data

Material	Plastic
Material type	TPE
min. temperature resistance	-35 °C
max. temperature resistance	100 °C
Colour	black

Product details

Width	40 mm
Length	10 m