

■ Base plate Type III Connection 3/4" Plate 137x70x8 mm

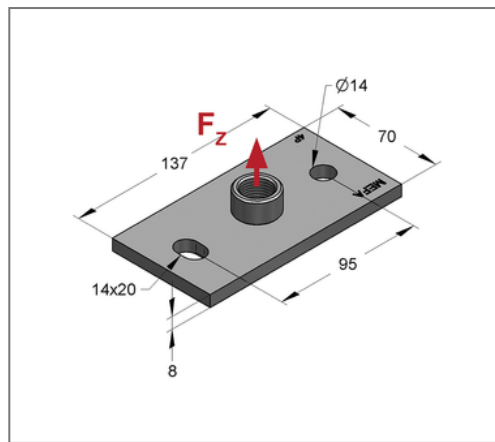
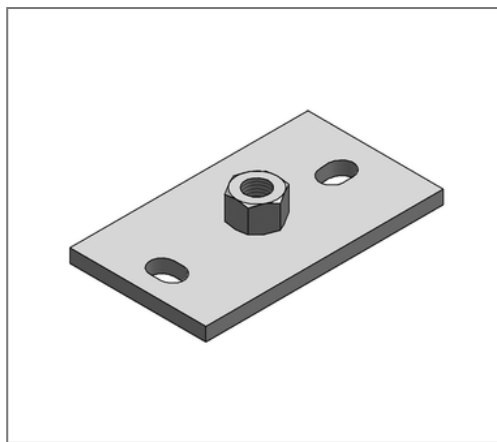

Commercial details

Part no.	059059901
EAN/GTIN	4250928447838
Packing unit	1 pcs
Quantity unit	pcs
Weight	0,634 kg/pc
Product group	05-059
Price unit	100

QR code



Specification

Number of fixing holes	2 pcs
------------------------	-------

Technical data

Material	Steel
Material type	S235
Surface	galvanized

Product details

Connection	3/4"
Length	137 mm
Width	70 mm
Thickness	8 mm
load F_z	10 kN
Elongated hole	14x20 mm
Hole distance lengthwise	95 mm

Remark

Note	suitable sound-decoupling see chapter 3a
------	--