

■ Console C-profile 45/52 L= 315 mm Plate vertical galv.

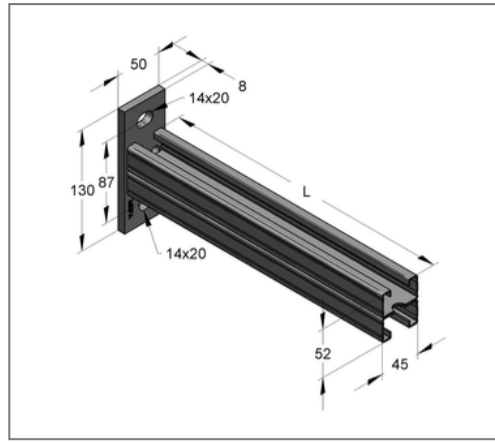

Commercial details

Part no.	18070315
EAN/GTIN	4250928437754
Packing unit	15 pcs
Quantity unit	pcs
Weight	1,21 kg/pc
Product group	02-083
Price unit	1

QR code



Specification

Application area	Console for the production of cantilever structures for the support of suspended and standing pipe loads.
------------------	---

Technical data

Material	Steel
Surface	galvanized

Product details

Width plate	50 mm
Length plate	130 mm
Hole distance	87 mm
Plate thickness	8 mm
Width profile	45 mm
Profile height	52 mm
Length console L	315 mm
Elongated hole plate	14x20 mm
load F1	2,93 kN
load F2	1,47 kN
load q0	9,3 kN/m
Profile thickness	1,5 mm